

DN3PS2

Original Betriebsanleitung

Original Instruction Manual

Stillstandswächter
für Ein- und
Dreiphasen
Motoren
ohne Sensorik

Standstill monitoring
for one and
three phases
motors
without sensor system







EU-Konformitätserklärung	EU declaration of conformity	
Dichiarazione di conformità UE	Dichiarazione di conformità UE	Declaración UE de conformidad

Die nachfolgend aufgeführten Produkte sind konform mit den Anforderungen der folgenden Richtlinien
The beneath listed products are in conformity with the requirements of the following directives
Les produits mentionés ci-dessous sont conformes aux exigences imposées par les directives suivantes
I prodotti sotto elencati sono conformi alle direttive sotto riportate
Los productos listados a continuación son conforme a los requisitos de las siguientes directivas

Maschinenrichtlinie	2006/42/EG	EMV Richtlinie	2014/30/EU	RoHS-Richtlinie	2011/65/EU
Machinery directive	2006/42/EC	EMC Directive	2014/30/EU	RoHS Directive	2011/65/EU
Directive Machines	2006/42/CE	Directive de CEM	2014/30/UE	Directive de RoHS	2011/65/UE
Direttiva Macchine	2006/42/CE	Direttiva EMV	2014/30/UE	Direttiva RoHS	2011/65/UE
Directiva de máquinas	2006/42/CE	Directiva CEM	2014/30/UE	Directiva RoHS	2011/65/UE

Folgende Normen sind angewandt:	a	• EN 55011: 2007+A1: 2007 (class B))	
Following standards are used:		• EN 62061: 2005	
Les normes suivantes sont appliquées:		• EN 61326-3-1: 2008	
Vengono applicate le seguenti norme:		• EN 61000-4-2: 1995 + A1: 1998 + A2: 2001	
Se utilizan los siguientes estándares:		• EN 61000-4-3: 2006+A1: 2008	
 <p>Product Safety Functional Safety</p> <p>www.tuv.com ID 0600000000</p> 		• EN 61000-4-4: 2004	
			• EN 61000-4-5: 1995 + A1: 2001
			• EN 61000-4-6: 1996 + A1: 2001
			• EN 61000-4-11: 2004
			• EN 61000-6-2: 2005
		b	• DIN EN 60947-5-1: 2004 + AC: 2005 + A1: 2009
		c	• EN 61508: Parts 1-7: 2010 (SIL 3)
		d	• DIN EN ISO 13849-1: 2008 + AC: 2009 (category 4/ PL e
		e	• EN 62061: 2005 + AC: 2010 + A1: 2013 (SIL CL 3)
		f	• EN 50178: 1997
	g	• EN 60204-1: 2006 + A1: 2009 + AC: 2010	

Zusatzanforderung: Supplementary requirements:	DIN EN ISO 9001: 2015/ DQS, Frankfurt, Reg.-Nr.:67542-01
---	--

Bezeichnung der Bauteile	Descrizione dei componenti	DN3PS2	Sicherheitsmodul zur Stillstandsüberwachung
Description of components	Descrizione de componente		Safety module for standstill monitoring
Description des composants			

EG-Baumusterprüfbescheinigung	EC-Type Test certificate	01/205/5028.01/15	2015-08-11
-------------------------------	--------------------------	-------------------	------------

Notifizierte Stelle	Organismo notificato	TÜV Rheinland Industrie Service GmbH
Notified body	Organismo notificado	Alboin Straße 56/ 12103 Berlin/ Germany
Organisme notifié		Kenn-Nr.: 0197

Bevollmächtigte Person für die Erstellung dieser Unterlagen	Authorized person for the issue of this document	Dirar Najib Esslinger Str. 84/ 72649 Wolfschlugen/ Germany
---	--	---

Wolfschlugen, 13. März 2018



Dirar Najib

Geschäftsführer/ CEO

Inhaltsverzeichnis	Seite	Contents	Page
Bestimmungsgemäße Verwendung	5	Intended usage	5
Zertifizierungsdaten	5	Certification data	5
Sicherheitsbestimmungen	6	Safety regulations	6
Wichtiger Hinweis	6	Important note	6
Gerätebeschreibung	7	Unit description	7
Funktion der Steuereingänge I11, I21	7	Function of the control inputs I11 and I21	7
Anschluss Schema	7	Connection schematic	7
DN3PS2, ID-No.: 33PS08	7	DN3PS2 ID-No.: 33PS08	7
Status der Meldeausgänge O1 und O2	7	Status of the monitoring outputs O1 and O2	7
Anzeige	8	Display	8
Überwachte Funktion	8	Monitored function	8
Schaltswelle Einstellung	8	Switching value adjustment	8
Einstellung der Anzugsverzögerungszeit für die Kontakte	9	Adjustment of the ON-delay time of the output contacts	9
Sicherheitsfunktionen während Parameter Einstellung	9	Safety function during parameter adjustment	9
Fehlerüberwachung	10	Faults monitoring	10
Überwachung einer Schutzhaube	11	Safety cover monitoring	11
Stillstandsüberwachung	11	Standstill monitoring	11
Technische Daten	12	General data	13
Kontakt Lebensdauer	14	Contact durability	14
Maßbilder	14	Dimensions	14

Varianten		Versions
33PS02	Standard	Standard
33PS03	Ansprechempfindlichkeit im mV Bereich	Sensitivity in mV range
33PS05	Muten für den Kontakt 13-14 über I11, I21 ist möglich	Mute for the contact 13-14 is possible
33PS08	2 Statusausgänge	2 Status outputs

<p>1. Bestimmungsgemäße Verwendung</p> <ul style="list-style-type: none"> • Antriebe von Bearbeitungsanlagen können sensorlos auf Stillstand überwacht werden. • Bei Antriebsbewegung oder Fehlern wechseln die potentialfreien NO Ausgangskontakte in die Ruhelage. • Sie sind so zu verwenden, dass die vorgesehene Schutzfunktion z.B. Verriegelung von Schutzeinrichtungen oder Auslösung von Not-Halt usw. ausgeführt wird. • DN3PS2 kann in Sicherheitsstromkreisen nach VDE 0113 T.1 eingesetzt werden. • Das Gerät ist zur Montage auf einer 35mm Norm-schiene vorgesehen. • Je nach äußerer Beschaltung ist maximal die Kategorie 4 / PLe nach EN ISO 13849-1 bzw. SIL 3 nach EN 61508 zu erreichen. 	<p>1.1 Intended usage</p> <ul style="list-style-type: none"> • The standstill of drives of machines can be monitored without sensor systems. • The NO potential free output contacts open if the drive moves or there is a failure in the system. • They can be used to lock a safety cover or for an emergency stop function. • DN3PS2 can be used in safety function circuit according to VDE 0113 T.1. • The unit can be mounted at a 35mm DIN rail. • In dependence of the external circuit maximal category 4 / PLe can be achieved according to EN ISO 13849-1 respectively SIL 3 according to EN 61508.
--	---

<p>Prüfgrundlage Siehe EG-Konformitätserklärung.</p>	<p>Testing based on See EU declaration of conformity.</p>
--	---

Zertifizierungsdaten	Certification data
-----------------------------	---------------------------

PFH(1/h)	4,0 x 10 ⁻⁸	4,0 x 10 ⁻⁸	Proof Test Intervall	PLd: 1/ Jahr	PLd: 1/ year	 IND.CONT.EQ 1ZD7 E227037
DC	90%	90%		PLe: 1/ Tag	PLd: 1/ day	
MTTFD	77 Jahre	Years		nach	according to	
DC _{AVG}	Mittel/	middle		IEC 61800-5-21	IEC 61800-5-21	

Produkt ist zugelassen als Sicherheitsgerät nach	Product is evaluated as safety device according	DIN EN ISO 13849-1: 2008-12, category 4, PL e EN 62061: 2005, SIL CL 3 EN 61508 Parts 1- 7:2010, SIL3
--	---	---

EMV-Richtlinie bescheinigt durch ELMAC GmbH, Bondorf, Reg. Nr.: DAT-P-206/05-00	EMC standard certified by ELMAC GmbH, Bondorf Reg. No.: DAT-P-206/05-00
CNL, USL: File E227037	CNL, USL: File E227037
Qualitätsmanagementsystem DQS zertifiziert nach DIN EN ISO 9001: 2015 Reg.-Nr.: 067542 QM 08	Quality management system DQS certified according to DIN EN ISO 9001: 2015 Reg.-No: 067542 QM 08

Zertifikat siehe www.dina.de	Certificate see www.dina.de
---	--

<p>Sicherheitsbestimmungen</p> <ul style="list-style-type: none"> • Das Gerät darf nur von einer Elektrofachkraft oder unterwiesenen Personen installiert und in Betrieb genommen werden, die mit dieser Betriebsanleitung und den geltenden Vorschriften über Arbeitssicherheit und Unfallverhütung vertraut sind. • Beachten Sie die VDE- sowie die örtlichen Vorschriften, insbesondere hinsichtlich der Schutzmaßnahmen. • Halten Sie beim Transport, der Lagerung und im Betrieb die Bedingungen nach EN 60068-2-1, 2-2 und 2-6 ein. • Werden die Vorschriften nicht beachtet, kann Tod, schwere Körperverletzung oder hoher Sachschaden die Folge sein. • Bei Not-Halt Anwendungen muss der automatische Wiederanlauf der Maschine verhindert werden. • Durch eigenmächtige Umbauten erlischt jegliche Gewährleistung. Es können dadurch Gefahren entstehen, die zu schweren Verletzungen oder sogar zum Tod führen. • Montieren Sie das Gerät in einen Schaltschrank mit IP54 Schutz. Staub und Feuchtigkeit können sonst zu Beeinträchtigungen der Funktionen führen. Der Einbau in einem Schaltschrank ist zwingend. • Sorgen Sie an allen Ausgangskontakten bei kapazitiven und induktiven Lasten für eine ausreichende Schutzbeschaltung. • Das Gerät ist unter Berücksichtigung der nach DIN EN 50274, VDE 0660-514 geforderten Abstände einzubauen. • Während des Betriebes stehen Schaltgeräte unter gefährlicher Spannung. Schutzabdeckungen dürfen nicht entfernt werden. • Wechseln Sie das Gerät nach dem ersten Fehlerfall aus. Entsorgen Sie es sachgerecht nach Ablauf der Lebensdauer. • Bewahren Sie diese Produktinformation auf. 	<p>Safety regulations</p> <p>The unit may only be installed and operated by those who are qualified electrical engineers or have received sufficient training and are familiar with both these instructions and the current regulations for safety at work and accident prevention.</p> <ul style="list-style-type: none"> • Follow VDE, EN as well as local regulations especially as regards preventative measures. • Transport, storage and operating conditions should all conform to EN 60068-2-1, 2-2 and 2-6. • Ignoring the safety regulations can lead to death, serious injury or cause considerable damage. • In emergency stop applications must be ensured that the machine cannot start up again automatically! • Any warranty is void following unauthorised modifications. This can lead to death, serious injury or cause considerable damage. • The unit should be mounted in a cabinet with a protection class of IP54. Otherwise dampness and dust could lead to functional impairment. The installation in a control cabinet is imperative. • Adequate fuse protection must be provided on all output contacts especially with capacitive and inductive loads. • The unit must be installed following the specification of DIN EN 50274, VDE 0660-514 regarding the required distances. • During operation, parts of the electronic switchgear carry high voltage. Removing protective covers is not allowed. • The device must be replaced after the first malfunction and properly disposed after reaches the end of its service life. • Keep the operating instructions.
<p>Wichtiger Hinweis</p> <ul style="list-style-type: none"> • Das beschriebene Produkt wurde entwickelt, um als Teil eines Gesamtsystems sicherheitsrelevante Funktionen zu übernehmen. • Das Gesamtsystem wird durch Sensoren, Auswerte- und Meldeeinheiten sowie Konzepte für sichere Abschaltungen gebildet. • Es liegt in der Verantwortung des Herstellers einer Anlage oder Maschine die korrekte Gesamtfunktion sicherzustellen. • Der Hersteller der Anlage ist verpflichtet, die Wirksamkeit des implementierten Sicherheitskonzepts innerhalb des Gesamtsystems zu prüfen und zu dokumentieren. • Dieser Nachweis ist nach jeder Modifikation am Sicherheitskonzept bzw. an den Sicherheitsparametern erneut zu erbringen. • DINA Elektronik ist nicht in der Lage, die Eigenschaften eines Gesamtsystems zu garantieren, das nicht von DINA konzipiert wurde. • DINA Elektronik übernimmt keine Haftung für Empfehlungen, die durch die nachfolgende Beschreibung gegeben bzw. impliziert werden. • Auf Grund der nachfolgenden Beschreibung können keine neuen, über die allgemeinen Lieferbedingungen von DINA Elektronik hinausgehenden Garantie-, Gewährleistungs- oder Haftungsansprüche abgeleitet werden. • Zur Vermeidung von EMV-Störgrößen müssen die physikalischen Umgebungs- und Betriebsbedingungen am Einbauort des Produkts dem Abschnitt EMV der DIN EN 60204-1 entsprechen. 	<p>Important note</p> <ul style="list-style-type: none"> • The described product has been developed as a part of a total system to take over safety related functions. • The whole system includes sensors, evaluation units, control units and a concept for safe switch-off. • The manufacturer of the total construction is in charge of ensuring the correct functionality of the total system. • The manufacturer is in charge of checking and proving the effectiveness of the safety concept. • Any modification at the safety parameters or the safety concept itself requires re-proving the safety concept. • DINA Elektronik cannot guarantee properties of systems that not have been established in their own responsibility. • DINA Elektronik does not accept liability for any recommendations derived from the following description. • Claims that go beyond the rights cited in the warranty are excluded. • To avoid EMC disturbances the physical environmental and functional requirements at the installation place have to be in accordance with chapter EMC of DIN EN 60204-1.

<p>Gerätebeschreibung</p> <ul style="list-style-type: none"> Die Eingangsklemmen L1, L2, L3 müssen ständig direkt mit dem zu überwachenden Antrieb verbunden sein. Schaltkontakte dürfen diese Verbindung auch bei abgeschaltetem Motor nicht unterbrechen. Zwischen den Klemmen L1, L2 und L3 und allen anderen Klemmen besteht eine 4KV Potenzialtrennung. Die Ausgangskontakte 13-14/ 23-24 sind sichere NO Kontakte mit Stopp Kategorie 0 nach EN 60204-1. Die Kontakte können zweikanalig parallel oder in Serienschaltung sicherheitsgerichtet verwendet werden. 	<p>Unit description</p> <ul style="list-style-type: none"> The input terminals L1, L2, L3 have to be always directly connected to the terminals of the monitored drive. No switching contacts are allowed between L1, L2, L3 and the terminals of the drive. There is a 4KV electrical isolation between L1, L2, L3 and all other terminals of DN3PS2. The output contacts 13-14/ 23-24 are safe NO contacts stop category 0 according to EN 60204-1. The contacts can be used as two-channel (parallel) or serial safety circuit.
<p>Funktion der Steuereingänge I11, I21</p> <ul style="list-style-type: none"> Nur bei den Versionen 33PS02 bis 33PS05 Die Stillstandsüberwachung ist inaktiv, wenn I11 und I21 mit 24V DC verbunden sind. Siehe Tabelle 1: Auswahl der Betriebsart Die Überwachung des Stillstands ist nur bei FA1 aktiv. Schutzeinrichtung ist dann bei Stillstand entriegelt. 	<p>Function of the control inputs I11 and I21</p> <ul style="list-style-type: none"> With versions 33PS02 to 33PS05 only The standstill monitoring is inactive if I11 and I21 are wired to 24V DC. See table 1: Function modes selection The standstill monitoring is active, if the function mode FA1 is selected. Safety cover is only unlocked at standstill.

<p>Anschluss Schema</p>	<p>Connection schematic</p>

<p>DN3PS2, ID-No.: 33PS08</p> <ul style="list-style-type: none"> Diese Version hat 2 nicht sichere Status Halbleiterausgänge. Die Ausgänge O1, O2 sind vorgesehen, den Geräte- und Betriebszustand an eine PLC zu übertragen. Die Eingänge I11, I21 sind nicht verfügbar. 	<p>DN3PS2, ID-No.: 33PS08</p> <ul style="list-style-type: none"> This version has 2 not safe status semi-conductor outputs. These outputs (O1, O2) may be used to transfer the current device- and operating status to a superordinate PLC. The control inputs I11 and I21 are not available.
---	---

Schaltzustand O1/ O2	O1	O2	Gerät	Unit	Motor	Motor	
Switching status O1/ O2	24V	24V	OK	OK	Stillstand	Standstill	
	0V	24V			Bewegung	Movement	
	0V	0V	Nicht OK	Not OK	Kein Einfluss	No influence	

<p>Anzeige</p> <ul style="list-style-type: none"> • Nach Anlegen der Betriebsspannung an die Klemmen A1 und A2 erfolgt zunächst ein Eigentest. • Während dessen bleiben die Ausgangskontakte in Ruhestellung und die LED OK leuchtet rot (2a). • Das Gerät ist betriebsbereit nach fehlerfreiem Test, sichtbar durch die grün leuchtende LED OK (2b). 	<p>Display</p> <ul style="list-style-type: none"> • After the connection of the power supply to the terminals A1 and A2 an internal test is started. • During this test the output contacts are open and the LED OK is illuminated red (2a). • The unit is ready after a faultless test displayed via the green illuminated LED OK (2b).
---	--

	Gerätetest	Stillstand	Bewegung	Auslauf	
Anzeige	Unit Test	Standstil	Movement	Run-out	Display

<p>Überwachte Funktion</p> <ul style="list-style-type: none"> • Die Stillstandserkennung erfolgt durch die Auswertung der induzierten Spannung (EMK) bei auslaufendem Motor. • Die Ausgangskontakte öffnen unverzüglich, wenn die EMK-Spannung die am Gerät eingestellte Spannung überschreitet. Die LED STOP erlischt (2c). • Bei Unterschreitung der eingestellten Spannung läuft der einstellbaren Einschaltverzögerung. Die LED STOP blinkt grün (2d). • Am Ende der Verzögerungszeit schließen die Ausgangskontakte. Die LED STOP leuchtet grün (2b). • Mechanische Blockade des Motors ist nicht überwacht. 	<p>Monitored function</p> <ul style="list-style-type: none"> • The detection of standstill happens via the measuring of the electromotive force (EMF) after the running-out of the drive. • The output contacts open immediately if the EMF value at the unit is higher than the adjustable voltage value. The LED STOP is not illuminated (2c). • With the undercut of the adjusted voltage the process of the switch on time delay starts. LED STOP is flashing green (2d). • At the end of the adjustable time delay the output contacts close (NO contacts). The LED STOP is illuminated green (2b). • A mechanical blockade of the drive is not monitored.
---	---

Tabelle 1			Table 1		
I11	I21	Funktionsart	Funktion	Function mode	Function
0V	0V	FA1	<p>geschlossen nur im Stillstand</p>	FM1	<p>closed during standstill only</p>
24V	0V	Nicht erlaubt		Not allowed	
0V	24V	Nicht erlaubt		Not allowed	
24V	24V	FA2	<p>geschlossen auch in Bewegung</p>	FM2	<p>closed also during movement</p>

<p>Schaltschwelle Einstellung</p> <ul style="list-style-type: none"> •Gerät an die Betriebsspannung anschließen. •Die Taste SET ca. 3s betätigt halten, bis alle LED rot blinken. •Nach der Betätigung blinken die LED rot entsprechend der Binärkombination der aktuellen Parameterstufe (Tabelle 2). •Mit jeder kurzen Betätigung der SET Taste wird die nächsthöhere Stufe zugewiesen. •Durch Betätigen über der SET Taste für ca. 2s wird der neue Wert dauerhaft gespeichert und der Einstellmodus verlassen. 	<p>Switching value adjusting</p> <ul style="list-style-type: none"> •Connect the unit to the power supply. •Activate button SET for approximately 3s. •After the actuation the LED are flashing red according to the binary combination of the actual parameters adjustment (table 2). •The value of the parameters increases one step after every short actuation of the button SET. •To memorize the new value permanently and quit the adjusting mode the button SET has to be actuated nearly 2s.
--	---

Tabelle 2: Einstellbereich der Stillstand Schaltschwelle	Table 2: Adjustment range of the standstill switching value
--	---

Tabelle 2	Position	1	2	3	4	5	6	7	8	9	10	11	12	13	14	15
Werteinstellung	LED: b8 / OK															
Table 2 value	LED: b4 / STOP															
adjustment	b2															
	b1															
Kontakte aktiv	Contacts on [mV]	50	55	60	65	70	75	80	200	230	250	300	350	400	460	500
Kontakte offen	Contacts off [mV]	120	120	120	120	120	120	120	1000	1000	1000	1000	1000	1000	1000	1000







































































































<p>Einstellung der Einschaltverzögerungszeit der Ausgangskontakte</p> <ul style="list-style-type: none"> •Gerät an die Betriebsspannung anschließen. •Taste SET ca. 6s betätigen, bis alle LED grün blinken. •Nach der Betätigung blinken die LED entsprechend dem aktuellen Parameterwert (Tabelle 3). •Jede kurze Betätigung erhöht den Wert eine Stufe. •Betätigen für ca. 2s speichert den neuen Wert. •Betätigungsstop \geq 20s beenden die Einstellung. •Alte Einstellung bleibt aktiv. •Die Funktion bleibt während der Einstellung erhalten. 	<p>Adjustment of the ON-delay time of the output contacts</p> <ul style="list-style-type: none"> •Connect the unit to the power supply. •Activate SET button ca. 6s till all LED are flashing green. •After the actuation the LED are flashing according to the actual parameter (table 3). •Every short actuation increases the value one step. •Activation for 2s saves the new parameter. •Activation stop \geq 20s ends the configuration. •Old parameter is active. •The function is active during the configuration.
--	--

Tabelle 3	Position	1	2	3	4	5	6	7	8	9	10	11	12	13	14	15
Werteinstellung	LED: b8 / OK															
Table 3 value	LED: b4 / STOP															
adjustment	b2															
	b1															
Verzögerung [s]	time delay [s]	0,5	1	2	3	4	5	6	7	8	10	12	14	16	18	20

<p>Achtung Eine Parametrierung ist nicht möglich im Fehlerfall beispielsweise bei Drahtbruch oder nicht angeschlossenem Motor ist.</p>	<p>Remark A Configuration is not possible during an error as example wire break or not connected motor</p>
---	---

<p>Sicherheitsfunktion während der Parametereinstellung</p> <ul style="list-style-type: none"> • Im aktiven Einstellmodus sind die Sicherheitsfunktion und die Fehlerüberwachung aktiv. • Bei Unterbrechung der Betriebsspannung während des Einstellmodus oder erfolgt für $\geq 20s$ keine Tastenbetätigung, wird die Einstellung ohne Speicherung beendet. • Die bisherigen Parameterwerte bleiben wirksam. • Neue Parameter sind nach Speicherung wirksam. 	<p>Safety function during the adjustment</p> <ul style="list-style-type: none"> • The safety function and the faults monitoring are also active during the adjustment mode. • A turn-off of the power supply or no actuation of the SET button $\geq 20s$ ends the adjustment without the storage of the new parameters. • The old adjustment remains process active. • New parameters are active after the storage.
--	--

<p>Fehlerüberwachung</p> <ul style="list-style-type: none"> • LED b8 blinkt rot bei folgenden Fehlern: Drahtbruch im Messkreis Inkonsistente Signale auf den einzelnen Phasen Ungültige Beschaltung der Eingänge I11/I21 Betriebsspannung außerhalb des Toleranzbereichs Interne Gerätefehler. • Die Fehlerüberwachung ist immer aktiv. • Im Fehlerfall sind die Ausgangskontakte abgeschaltet. • Nach Behebung externer Fehler herrscht Normalbetrieb. • Gerät mit internem Fehler muss von DINA überprüft werden. 	<p>Faults monitoring</p> <ul style="list-style-type: none"> • LED b8 is red flashing if follow faults are existing: Wire breakage in the measurement circuit Inconsistent signals at the single phases Not allowed connection of the inputs I11/I21 Power supply out of the tolerance range internal unit faults Internal unit error • The faults monitoring is always active. • The output contacts are open if there is a fault. • After solve of external faults the function will be OK. • Unit with internal faults must be repaired of DINA.
---	--

b8																									Interner Gerätefehler	Internal unit faults
b8																									Unzulässige Betriebsspannung	Illegal power supply
b8																									Drahtbruch an Sensorleitung	Wire break sensor input
b8																									Einkanaliges Signal	One channel signal
b8																									Relaisfehler	Relay fault

Überwachung einer Schutzeinrichtung	Safety cover monitoring
<p style="text-align: center;">Betriebsart FA1</p> <ul style="list-style-type: none"> • Für die Überwachung einer Schutzeinrichtung sind die Eingänge I11 und I21 spannungslos. • Die Stillstandsüberwachung ist dadurch ständig aktive. • Über die Kontakte 13-14/ 23-24 (serielle Schaltung) wird die Verriegelung der Schutzeinrichtung angesteuert. • Die Kontakte schließen erst dann, wenn der Antrieb der Anlage im Stillstand hart. • Danach ist die Schutzeinrichtung entriegelt. <p>(2) Verriegelung der Schutzeinrichtung</p>	<p style="text-align: center;">Function mode FA1</p> <ul style="list-style-type: none"> • The inputs I11 and I21 are dead for the monitoring of the safe cover. • The standstill monitoring is thereby always active. • The safe cover enabling is controlled by the contact 13-14/ 23-24 (serial circuit). • The contacts close after the permanent standstill of the drive of the construction. • The safety cover is unlocked. <p>(2) safety cover interlocking</p>

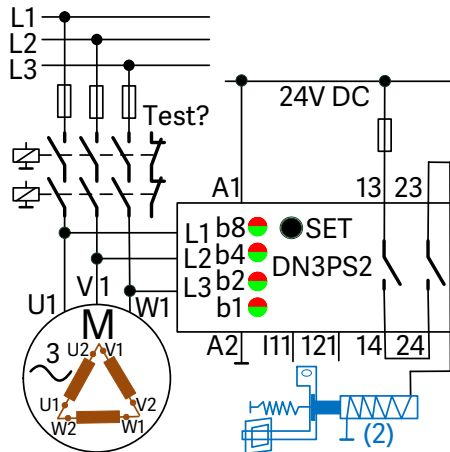

Stillstandsüberwachung	Standstill monitoring
<p style="text-align: center;">Betriebsart FA2</p> <ul style="list-style-type: none"> • Für die Überwachung des Stillstands werden die Eingänge I11 und I21 über den Schalter der Schutzeinrichtung mit 24V DC angesteuert. • Im Automatikbetrieb (Schutzeinrichtung geschlossen) ist die Überwachung nicht aktive. • 13-14 und 23-24 sind dauerhaft geschlossen und die LED STOP leuchtet grün. • Ein Öffnen der Schutzhaube bewirkt den Wechsel zu Betriebsart FA1. • Eine Antriebsbewegung löst die Not-Halt Funktion aus. <p>(1) Schutzeinrichtung Schalter</p>	<p style="text-align: center;">Function mode FA2</p> <ul style="list-style-type: none"> • The inputs I11 and I21 are controlled by the safety cover switch with 24V DC during the standstill monitoring. • During the automatically function mode the monitoring is inactive (safety cover is closed). • 13-14 and 23-24 are permanently closed and the LED STOP illuminates green. • An opening of the safety cover activates the function mode FA1. • A drive movement causes an emergency stop. <p>(1) safety cover switch</p>

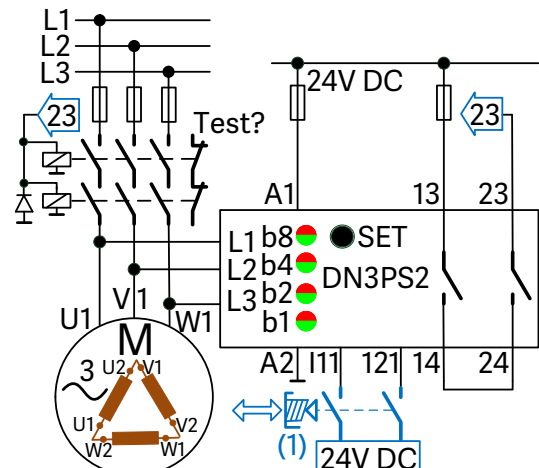
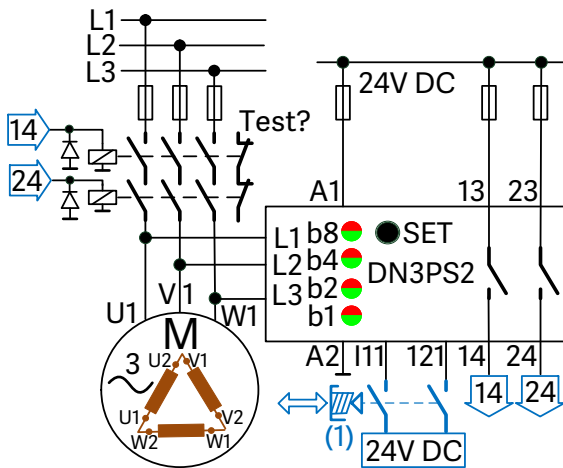

Technische Daten

Umgebungsdaten	
Umgebungstemperatur	-20 bis +55°C DIN IEC 60068-2-3
Lagertemperatur	-40 bis +85°C DIN IEC 60068-2-3
Höhenlage des Einsatzes	< 2000m über NN
Rüttelfestigkeit in allen 3 Ebenen	Sinus 10–55Hz, 0,35mm, 10 Zyklen, 1 Oktave/min
Luft- und Kriechstrecken	DIN EN 50178, sichere Trennung
Mindesteinbauschutzart	Einbau in einem Schaltschrank ist zwingend, Schutzart \geq IP54
Eingangsdaten	
Betriebsspannung UB	24V DC -15 % / +10 %, Verpolschutz
Stromaufnahme bei 24V DC	\leq 80mA
Stromaufnahme L1, L2, L3	0,35mA bei 690V AC/ 5KHz
Eingangsspannung an L1, L2, L3	90 bis 690V AC
Leistungsaufnahme an A1/ A2	Typ. 2,8W
Statusanzeige	4 x LED 2-farbig
Schutzbeschaltung	Überspannungsschutz und Verpolschutz für Betriebsspannung
Ausgangskontaktdaten	
Kontaktausführung	2 Freigabekontakte
Kontaktschaltstrom	\geq 10mA, \leq 8A
Schaltspiele nach IEC/EN 60947-4-1	100.000 / AC1: 230V/ 8A, 100.000 / DC1: 24V/ 8A
Schaltstrom nach IEC/EN 60947-5-1	AC15: 230V/3A, DC13: 24V/4A
Mechanische Lebensdauer	> 20 x 10 ⁶ Schaltspiele
Kontaktwerkstoff	AgNi10
Kontaktabsicherung	5A träge
Max. Schaltspiele	360 Zyklen/h bei AC15/DC13
Kurzschlussfestigkeit	200A/ Automat B6 Vorsicherung / 800A/ 6A gL Schmelzsicherung gG
Ansprech-, Rückfallzeit	Typisch 20ms
Ausgänge O1, O2	\leq 100mA(UB-1V) kurzschluss- und überlastsicher, nur bei ID-No.: 33PS08
Allgemeine technische Daten	
Einschaltdauer	100 %
Schutzart	IP20 Gehäuse
Einbaulage	beliebig
Gehäusematerial/ Typ	Polyamid PA nicht verstärkt/ ME/ Fa. Phoenix Contact
Bemessungsisolationsspannung	250V AC
Stoßspannungsfestigkeit	4KV
Umwelt	Verschmutzungsgrad 2
Überspannungskategorie	III
Abmessungen	B x H x T/ 22,5 x 114 x 111 mm
Anschlussklemmen/ Material	Federkraftklemmen steckbar/ Polyamid PA/ Fa. Phoenix Contact
Leiterquerschnitt (nur flexibel)	0,25 - 2,5mm ² mit Aderendhülse
Anschlussdraht	60/75°C Kupfer
Leiterquerschnitt AWG	12...24
Abisolierlänge	8 mm

Technical data

Environment data	
Environment temperature	-20 to +55°C DIN IEC 60068-2-3
Storage temperature	-40 to +85°C DIN IEC 60068-2-3
Height of usage location	< 2000m over sea level
Vibration resistance 3 axis	Sinus 10–55Hz, 0,35mm, 10 cycles, 1 octave /min
Air and creep age distance	DIN EN 50178, safe isolation
Protection class	Installation in a closed cabinet only with min. IP54
Input data	
Operating voltage (U _B)	24V DC -15 % / +10 %, reverse protection
Current draw/ 24V DC	80mA
Current draw at L1, L2, L3	max. 0,35mA at 690V
Input voltage at L1, L2 and L3	90V to max. 690V AC
Power consumption A1/ A2	Typical 2,8W
Status display	4 x LED 2-colors
Protection wiring	Overvoltage/ inverse polarity protection
Output data	
Contact construction	2 enabling contacts
Contact current	≥ 10mA, ≤ 8A
Switching cycles according to IEC/EN 60947-4-1	100.000 / AC1: 230V/ 8A, 100.000 / DC1: 24V / 8A
Switching current according to IEC/EN 60947-5-1	AC15: 230V/3A / DC13: 24V/4A
Mechanical life	> 20 x 10 ⁶ switching cycles
Contact material	AgNi10
Contact fusing	5A slow
Maximal switching cycles	360 cycle/h at AC15/ DC13
Short-circuit strength	200A/automat B6, 800A/safety fuse 6A gL
Reaction, dropout time	Typical 20ms
Outputs O1, O2	≤ 100mA(UB-1V) short and overload safe, at ID-No.: 33PS08 only
General data	
Duty cycle	100%
Degree of protection	IP20 housing
Mounting position	optional
Housing material/ Type	Polyamide PA not increased/ ME/ Fa. Phoenix Contact
B Rated insulation voltage	250V AC
Impulse withstand voltage	4KV
Environment	Pollution degree 2
Overvoltage category	III
Dimensions	W x H x T/ 22,5 x 114 x 111 mm
Connection terminals/ Materiel	spring load clamps, pluggable/ Polyamide PA/ Fa. Phoenix Contact
Cable cross section (flexible only)	0,25 – 2,5mm ² with wire end sleeve
Connection wire	60/75°C copper
Cable cross section AWG	12...24
Remove insulation	8 mm

Kontakt Lebensdauer				Contact durability			
Jahr: 260 Tage	Year: 260 days	Schaltspannung 24V DC	Switching voltage: 24V DC			Lebensdauer	Durability
Tag: 8h	Day: 8H	Last	Load	DC1	DC13	Jahr	Year
		Schaltstrom	Switching current	1A	1A		
				769	91	5	5
		Schaltspiele	Cycles	384	45	10	10
				192	23	20	20
AC1: nicht induktiver Last / 250V AC				AC1: non inductive load / 250V AC			
AC15: elektromagnetischer Last / 230V AC				AC15: electro magnetically load / 230V AC			
DC1: nicht induktiver Last / 24V DC				DC1: non inductive load / 24V DC			
DC13: elektromagnetischer Last / 24V DC				DC13: electro magnetically load / 24V DC			

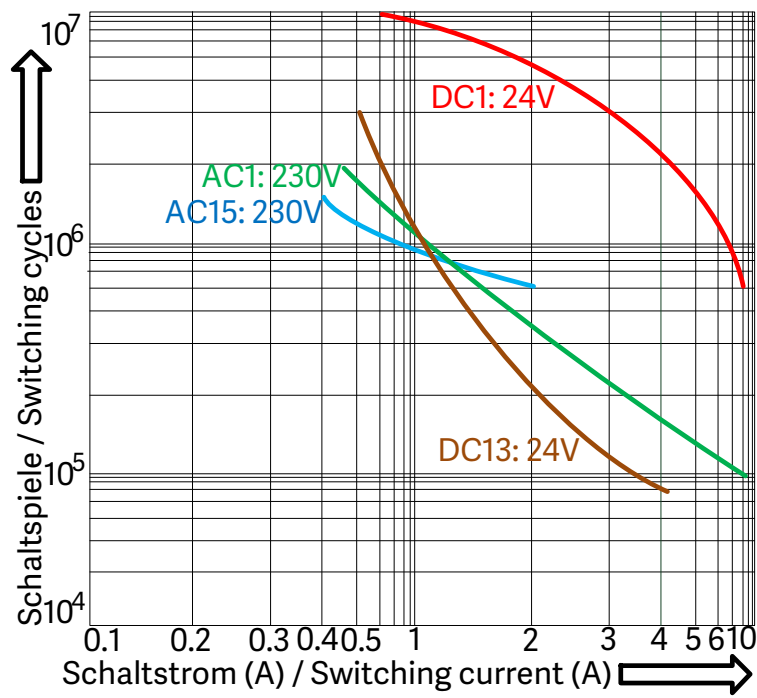

Gehäusematerial: Polyamid PA nicht verstärkt Housing material: Polyamide PA unamplified

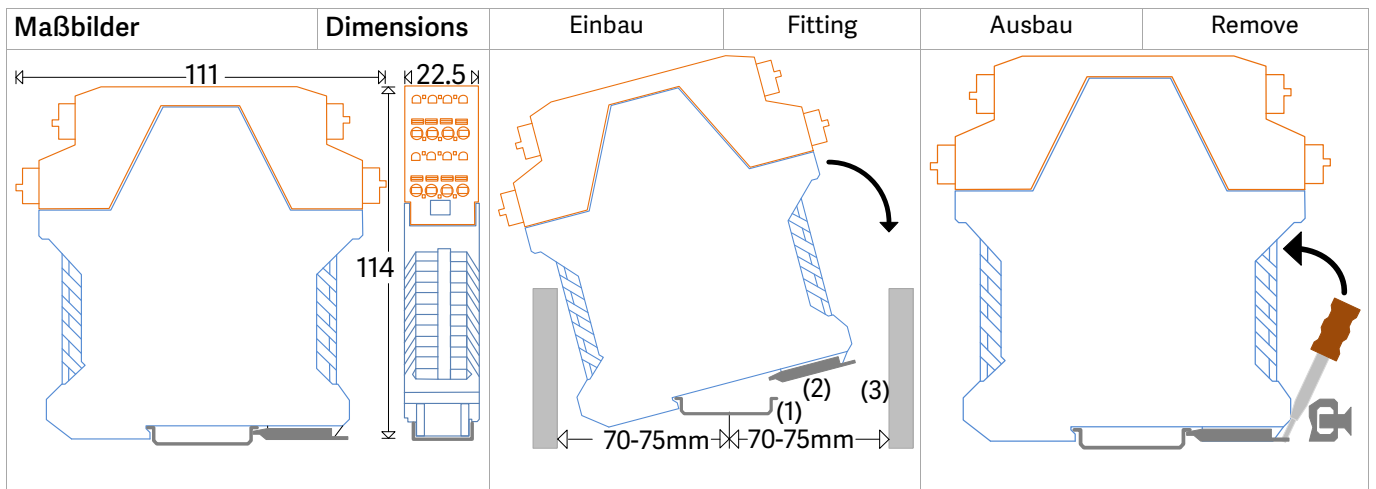

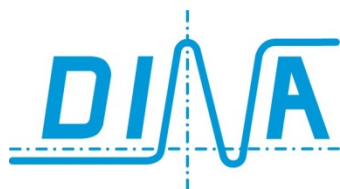

wir sind sicherheit.
we are safety

DINA Elektronik GmbH
Esslinger Straße 84
72649 Wolfschlugen
Tel. 07022/95 17-0
Fax 07022/95 17 700
www.dina.de
info@dina.de